

Serie FLAT

Technische Informationen

Technical information

Informazioni tecniche

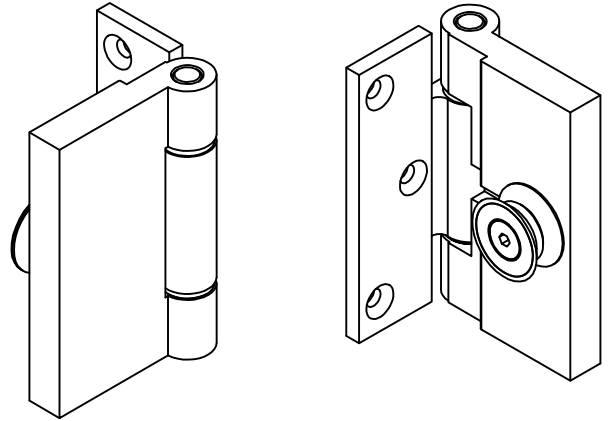

Art. C0199

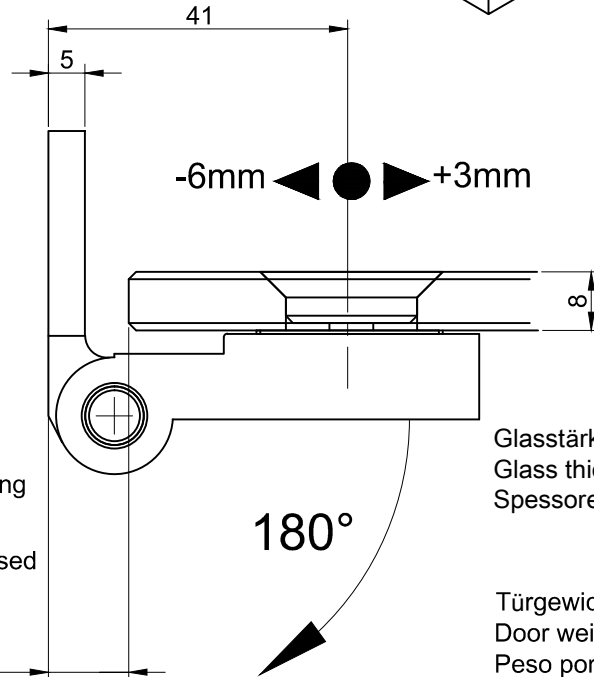

Spalt für die verwendete Dichtung zu berechnen

Calculate the gap for the seal used

Calcolare la distanza per la guarnizione utilizzata

Glasstärke
Glass thickness
Spessore vetro

8-10mm

Türgewicht, (2 Scharniere)
Door weight (2 hinges)
Peso porta (2 cerniere)

40Kg max.

Türabmessung max.
Door size max.
Dimensione porta max.

900x1900mm

